



Cover 1:
Aaron Silver

Cover 3:
Jive Charcoal

Cover 2:
Crinkle Pearl / Grey

Chrome Feet

Zander Collection

foamflex™
Award Winning Seating Technology

Colours represented are to be used as a guide only.
Please refer to manufacturers swatch for a more accurate colour match.

Please note that colour shadings can vary slightly from each roll of fabric.
We cannot guarantee a precise match to these samples or between cut lengths and upholstered goods.

19/01/2021

ZANDER COVER GUIDE: STANDARD BACK ONLY

Please use this guide when ordering the following pieces to clarify cover options.

Corner Group: L2, CO, R2 (LH2, COR, RH2)

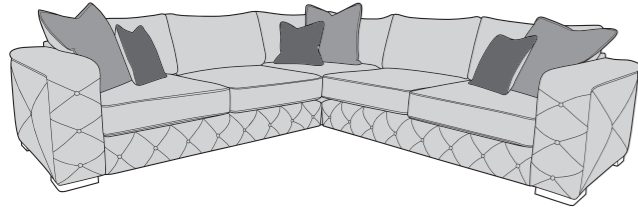

Corner Group: L2, CO, R1 (LH2, COR, RH1)

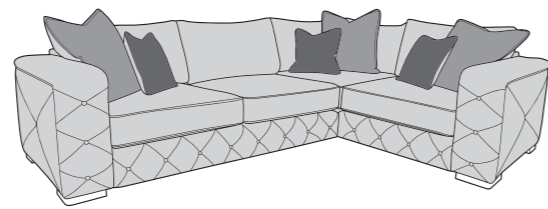

Corner Group: L1, CO, R2 (LH1, COR, RH2)

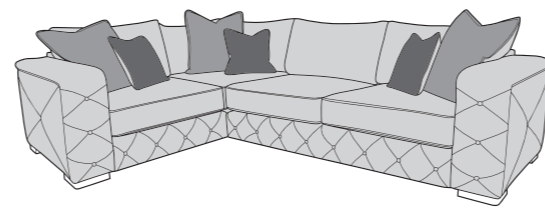

Corner Group: L1, CO, R1 (LH1, COR, RH1)

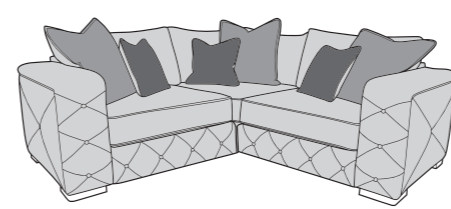

Armless Unit (AU)

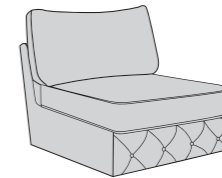

4 Seater Modular Sofa

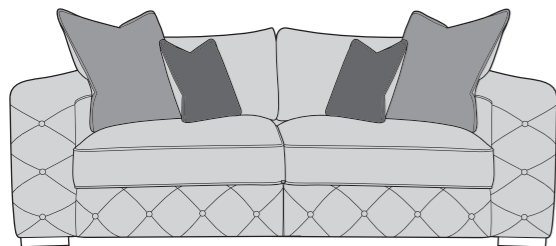

3 Seater Sofa (3ST)

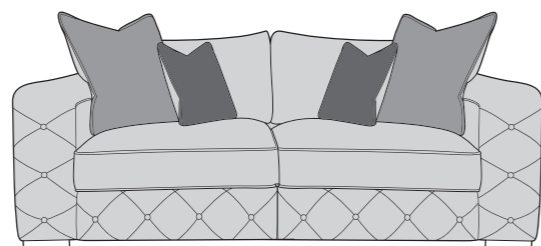

2 Seater Sofa (2ST)

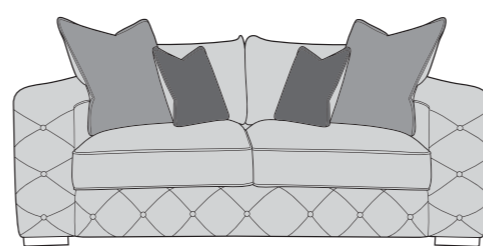

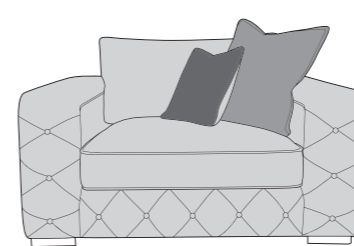

Love Chair (LOV)

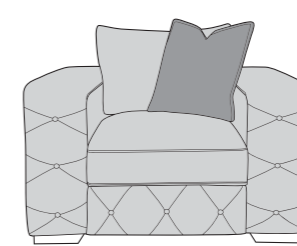

Arm Chair (1ST)



-  **COVER 1**
(BODY)
-  **COVER 2**
(LARGE
SCATTER)
-  **COVER 3**
(SMALL
SCATTER)

Scatter Cushions

Large Scatter
Cushions

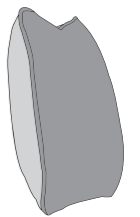

Flanged Edge
Front = Cover 2
Back = Cover 1

Small Scatter
Cushions

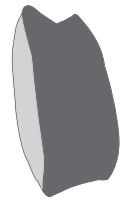

Flanged Edge
Front = Cover 3
Back = Cover 1

ACCENT PIECES

Merlin
Accent Chair (ACH)

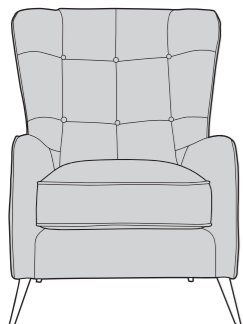

Zander
Large Footstool (FST)

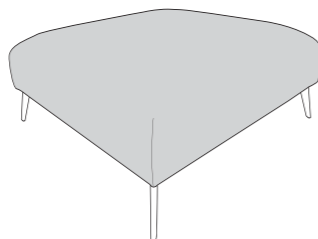

Link
Storage Footstool (FSS)

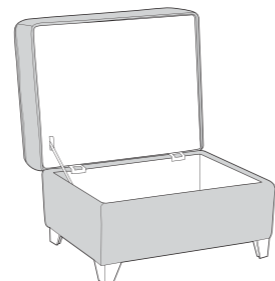

ZANDER DIMENSIONS (CM)

AVAILABLE PIECES	HEIGHT 1	OUTBACK HEIGHT	WIDTH 2	DEPTH 3	ARM HEIGHT	SEAT HEIGHT 4	SEAT DEPTH 5	SEAT WIDTH 6	ACCESS DIAGONAL 7	WEIGHT (KG)	SCATTER CUSHION NO.
L2, CO, R2 (LH2, COR, RH2) GROUP	81	67	277	277	64	44	67	N/A	N/A	145	6 (3 Large, 3 Small)
L2, CO, R1 (LH1, COR, RH2) GROUP or L1, CO, R2 (LH1, COR, RH2) GROUP	81	67	277	203	64	44	67	N/A	N/A	127.5	6 (3 Large, 3 Small)
L1, CO, R1 (LH1, COR, RH1) GROUP	81	67	203	203	64	44	67	N/A	N/A	110	6 (3 Large, 3 Small)
L2/R2 (LH2/RH2) UNIT	81	67	178	99	64	44	67	157	202	56	2 (1 Large, 1 Small)
L1/R1 (LH1/RH1) UNIT	81	67	104	99	64	44	67	N/A	N/A	38.5	2 (1 Large, 1 Small)
AU (ALU) - ARMLESS UNIT	81	67	79	99	N/A	44	67	N/A	N/A	24.5	N/A
CORNER UNIT (COR)	81	67	99	99	N/A	44	67	N/A	139	33	2 (1 Large, 1 Small)
4 SEATER MODULAR SOFA (4MD)											
4 SEATER MODULAR SOFA (4MD)	81	67	227	99	64	44	67	N/A	N/A	82.5	4 (2 Large, 2 Small)
3 SEATER SOFA (3ST)	81	67	199	99	64	44	67	152	222	77	4 (2 Large, 2 Small)
2 SEATER SOFA (2ST)	81	67	179	99	64	44	67	133	203	66.5	4 (2 Large, 2 Small)
LOVE CHAIR (LOV)	81	67	136	99	64	44	67	90	168	60.5	2 (1 Large, 1 Small)
ARM CHAIR (1ST)	81	67	106	99	64	44	67	60	145	52.5	1 Small
ACCENT PIECES											
MERLIN ACCENT CHAIR (ACH)	104	N/A	72	84	59	53	53	54	97	25	N/A
LARGE FOOTSTOOL (FST)	36	N/A	102	102	N/A	N/A	N/A	N/A	N/A	21.5	N/A
STORAGE FOOTSTOOL (FSS)	45	N/A	61	50	N/A	N/A	N/A	N/A	75	12.5	N/A



* Hardwood & composite board frame.

* Dowelled, screwed, glued & stapled joinery.

* Chrome & Wood foot options.

* Fibre filled backs for added comfort.

* Feather filled scatters included. 

* Award winning foamflex seat interior with 5 year guarantee.

* Serpentine seat springs & silent wire.

* Elasticated back webbing.

DIMENSION GUIDE

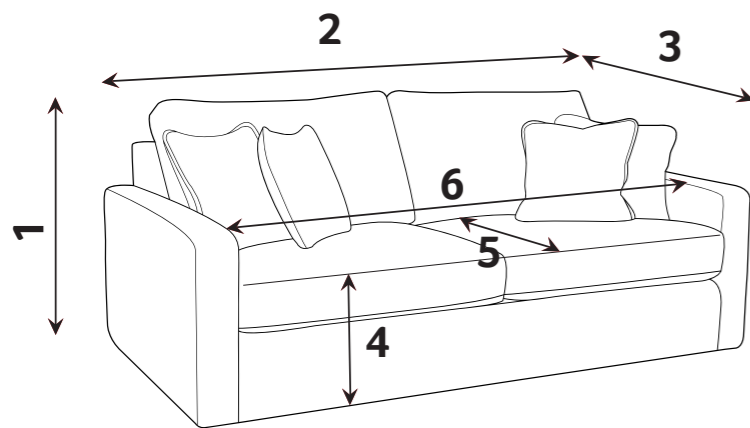

1 - HEIGHT
2 - WIDTH

3 - DEPTH
4 - SEAT HEIGHT

5 - SEAT DEPTH (STD & PILLOW)
6 - SEAT WIDTH

7 - DIAGONAL ACCESS

Check the diagonal access dimension to ensure furniture will fit in your home.

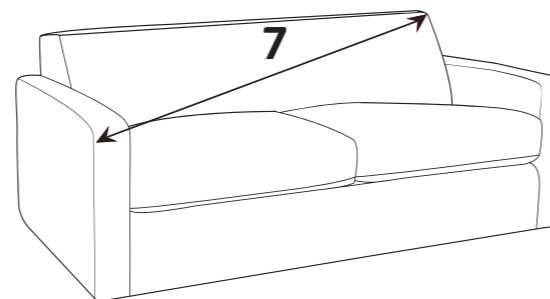

Illustrations used for reference only.

foamflex

Our new expertly engineered foam seat interior gives you the comfort of fibre with the retention of foam.

CARE GUIDE

To improve the longevity of your hand-made furniture, we recommend rotating cushions (where applicable).

For further information on maintaining your furniture, please refer to the Care Guide located under the seat platform.



Our foamflex seat interiors have been granted the FIRA GOLD Award, a mark of quality under-pinning all necessary testing of the product materials, design and production techniques.

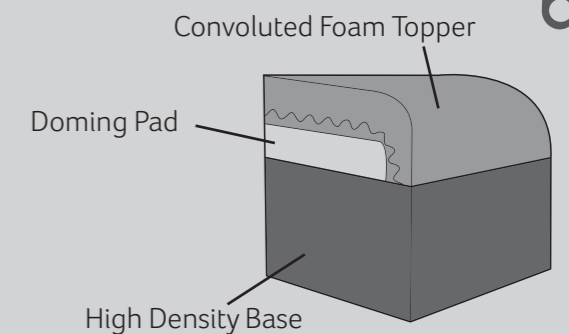

Footstool Feet:

Chrome Mid Oak Antique



FOOT OPTIONS:
Feet require fitting.

Please note: All dimension are approximate. Allow tolerance of +/- 2.5cm.



19/01/2021